

Article number: 0106081

Description: Retaining ring JV 68

Measures

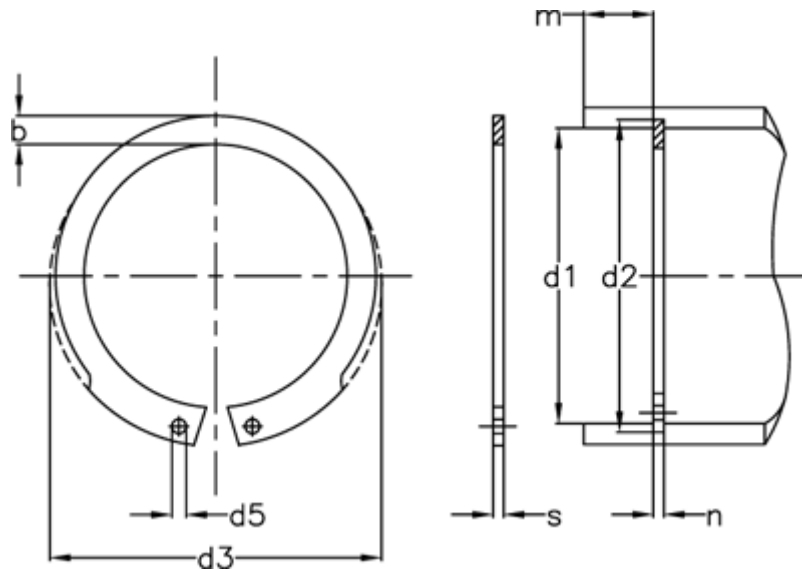

AN mm ²	= 163	FRg kN	= 21.0	tol	= 0.3
b	= 5.7	FR kN	= 123.0	tol	= -0.07
d1	= 68	g	= 2.5	tol	= +1,10-0,46
d2	= 71.0	K kN-mm	= 220.0	tol	= +0,30
d3	= 72.5	m min	= 2.65	Tong	= ZGJ-3
d5 min	= 2.5	Nominal drive	= 4.5	Weight kg/1000	= 17.75
Description	= JV 68	s	= 2.50		
FN kN	= 27.20	t	= 1.50		